

## General description

Access doors allow easy admittance to the ventilation ducting for the purpose of inspection and cleaning.

Access doors are flat for rectangular ducting and curved for round ducting.

Available in steel, stainless steel and for high temperature application.

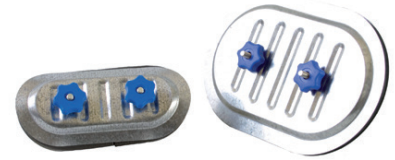

## Technical description

PANELS	MATERIAL	Stainless steel 304
SEALING GASKET	TYPE	High quality EPDM
	DIMENSION	6 mm x 15 mm
	DENSITY	+/- 33 Kg / m <sup>3</sup>
	TEMPERATURE RANGE	- 40 / + 90 °C
COMPONENTS COMPRESSION SYSTEM	SCREWS	2 stainless steel 304 screws: M8X40 or M10X40 crimped on internal panel
	SPRINGS	2 compressions springs
	KNOBS	2 plastics knobs with metal insert M8 or M10
Self-adhesive template comes with each door, for accurate cut-out		

## Sizes

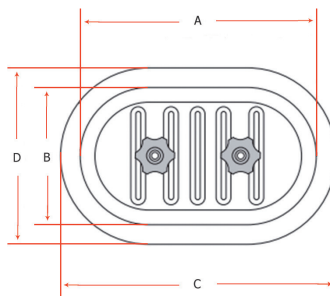

DOOR TYPE	NOMINAL SIZES (mm)	ACTUAL SIZES (mm)			
		The format is oblong, and the radius of the 4 angles is equivalent to the small size divided by 2.			
		A	B	C	D
18	180 x 80	170	72	197	101
20	200 x 100	200	100	219	117
25	250 x 150	250	150	274	186
30	300 x 200	300	200	329	228
40	400 x 300	380	280	403	303
50	500 x 400	500	400	532	432

Information contained herein is based on careful tests and experience. It reflects our knowledge and is for guidance purpose only. It is given in good faith and user should ensure that the product is fit for purpose before any application. The quoted values are average and should not be taken as maximum or minimum values for specific purposes. Manufacturer and distributor are not responsible for any non-recommended use or consequential damage.

2016.09.15

**Selection chart**

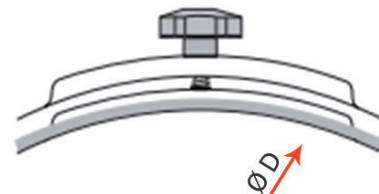

DOOR SIZE DUCT. DIA	CAD-18-dia 180x80 mm	CAD-25-dia 250x150 mm	CAD-30-dia 300x200 mm	CAD-40-dia 400x300 mm	CAD-50-dia 500x400 mm	CAD-60-dia 600x450 mm
100 mm	Standard	+	-	-	-	-
125 mm	Standard	+	-	-	-	-
150 mm	+	+	-	-	-	-
160 mm	Standard	Standard	-	-	-	-
180 mm	+	+	-	-	-	-
200 mm	Standard	Standard	-	-	-	-
224 mm	+	+	-	-	-	-
250 mm	+	Standard	-	-	-	-
280 mm	+	+	-	-	-	-
300 mm	+	+	-	-	-	-
315 mm	-	Standard	Standard	-	-	-
355 mm	-	Standard	Standard	-	-	-
400 mm	-	Standard	Standard	Standard	-	-
450 mm	-	Standard	Standard	Standard	-	-
500 mm	-	Standard	Standard	Standard	-	-
550 mm	-	-	+	+	-	-
560 mm	-	-	+	Standard	-	-
600 mm	-	-	+	+	-	-
630 mm	-	-	+	Standard	Standard	-
700 mm	-	-	-	+	+	-
710 mm	-	-	-	Standard	Standard	Standard
800 mm	-	-	-	Standard	Standard	Standard
850 mm	-	-	-	+	+	+
900 mm	-	-	-	Standard	Standard	Standard
1000 mm	-	-	-	+	Standard	Standard
1120 mm	-	-	-	+	Standard	Standard
1250 mm	-	-	-	+	Standard	Standard
1400 mm	-	-	-	-	-	Standard
1500 mm	-	-	-	-	-	Standard
1600 mm	-	-	-	-	-	Standard
1800 mm	-	-	-	-	-	Standard

+ : Available on request  
 - : Not available

Information contained herein is based on careful tests and experience. It reflects our knowledge and is for guidance purpose only. It is given in good faith and user should ensure that the product is fit for purpose before any application. The quoted values are average and should not be taken as maximum or minimum values for specific purposes. Manufacturer and distributor are not responsible for any non-recommended use or consequential damage.

**Selection of curving diameters**

DUCT DIAMETER (mm)	RECOMMENDED DOOR CURVING Ø (mm)
80 - 120	100
121 - 150	125
151 - 190	160
191 - 240	200
241 - 300	250
301 - 340	315
341 - 380	355
381 - 430	400
431 - 480	450
481 - 530	500
531 - 600	560
601 - 670	630
671 - 750	710
751 - 850	800
851 - 950	900
951 - 1050	1000
1050 - 1150	1120
1151 - 1300	1250

**Selection of Access Door (Based on EN 12097)**

CIRCULAR DUCT		RECTANGULAR DUCT	
Nominal duct diameter (mm) D	Minimal size of access door (mm) A x B	Width of duct where access door is fitted (mm) S	Minimal size of access door (mm) A x B
$100 \leq D < 200$	180 x 80	$S \leq 200$	180 x 80
$200 \leq D \leq 315$	250 x 150	$200 < S \leq 400$	300 x 200
$315 < D \leq 500$	300 x 200	$400 < S \leq 500$	400 x 300
$500 < D$	400 x 300	$500 < S$	500 x 400

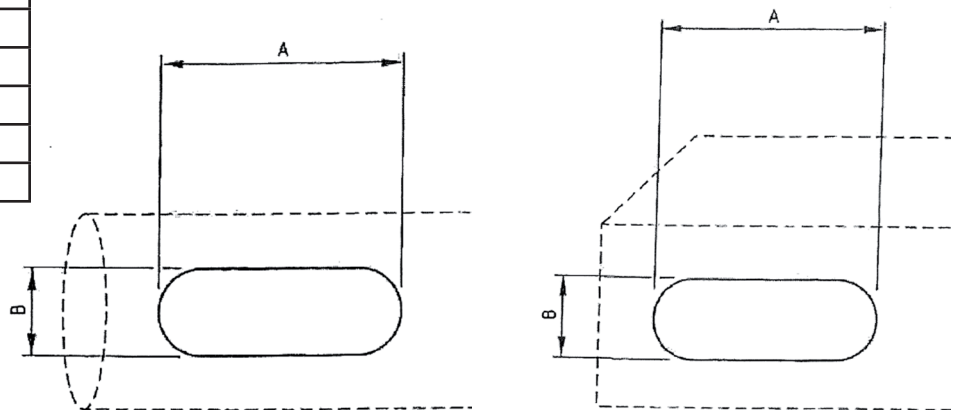

Access door needs to be fitted :

- at least every 7,5 m
- after every change of airflow direction of more than 45°
- after every change of duct diameter within the duct network
- before and after every fitting (dampers, fire dampers, filters, duct fans, duct heaters,...)

Information contained herein is based on careful tests and experience. It reflects our knowledge and is for guidance purpose only. It is given in good faith and user should ensure that the product is fit for purpose before any application. The quoted values are average and should not be taken as maximum or minimum values for specific purposes. Manufacturer and distributor are not responsible for any non-recommended use or consequential damage. 2016.09.15

## Application

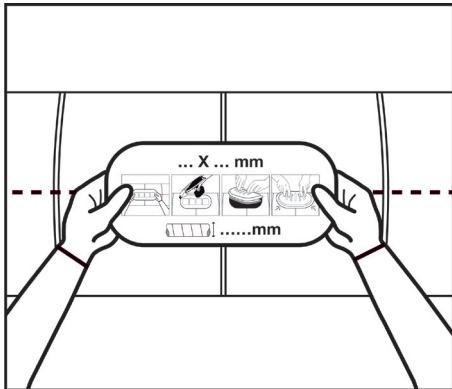

1. Stick self-adhesive template on to duct  
(a template is provided with each door)

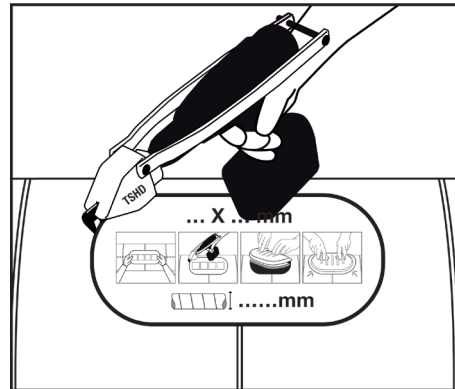

2. Using Turbo Shears or similar cut around  
template taking care not to exceed the size of  
the template (the door will function correctly  
when cut to template size +0 mm -3 mm).  
For details of the Turbo Shear please refer to  
Malco Tools Datasheet

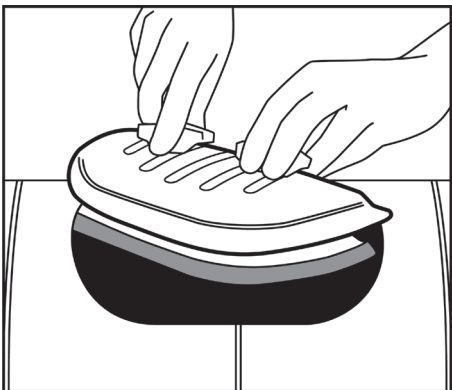

3. Install door by unscrewing the hand  
knobs until thread is level with top of bolt.  
Using both hands place the door in the  
hole at an angle.

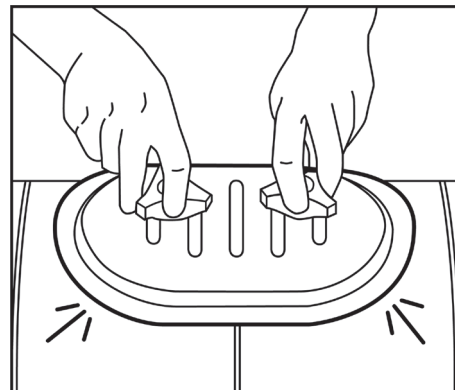

4. Turn straight and pull out slightly to  
align. Then tighten knobs.